

PRODUCT SPECIFICATIONS / INFO

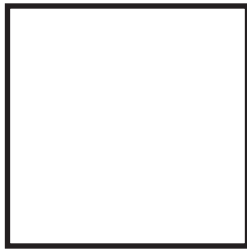

Color: White



NEMA: 5-15R

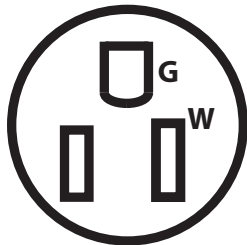

Newer Technology Power2USB NWTPWR2U15ATRW

UPC Code: 811643012721

Country Of Origin: China

Description:

AC Description: 15 Amp Tamper Resistant, 125 Volt, NEMA 5-15R, 2P, 3W, Decora Body Duplex Receptacle, Straight Blade, Residential Grade, Self Grounding, Back & Side Wired, Steel Strap - White

DC Description: 5.2 Volt, 2500mA (12.5W) Duplex USB Charging Receptacle, With Integrated On/Off Safety Switch for USB Power

Product Features

AC Horsepower Ratings

At rated voltage: 1/2HP

Electrical Specifications

| | |
|----------------------------------|---|
| Grounding: | Self |
| Amperage: | 15 Amp |
| Voltage: | 125 Volt |
| NEMA: | 5-15R |
| Pole: | 2 |
| Wire: | 3 |
| Dielectric Voltage: | Withstands 2000V per UL 498 |
| Overload Test, HP Rating: | 125V AC, 58.8A |
| Current Limiting: | Full Rated Current |
| Temperature Rise: | Maximum contact temperature rise 27.6°C; Max terminal temperature rise 19.8 °C |

Environmental Specifications

| | |
|-------------------------------|--------------------|
| Flamability: | Rated V-2 per UL94 |
| Operating Temperature: | -40C to 60C |

Material Specifications

| | |
|-------------------------|------------------------------|
| Face Material: | Polycarbonate |
| Body Material: | Polycarbonate |
| Line Contacts: | Brass Triple-Wipe .031 Thick |
| Terminal Screws: | Brass 10-32 |
| Grounding Screw: | Brass 8-32 |
| Strap Material: | Zinc-Plated Steel |
| Clamp Nuts: | Zinc-Plated Steel |
| Ground Clips: | Brass-Plated |
| Color: | White |

Mechanical Specifications

| | |
|-------------------------------|---|
| Terminal ID: | Brass-Hot, Green-Ground, Silver-Neutral |
| Terminal Accomodation: | 14-10 AWG |
| Product ID: | Ratings are marked on device |
| Termination: | Side |

Standards and Certifications

| | |
|-------------------------------|--------------|
| NEMA: | WD-1 & WD-6 |
| ANSI: | C-73 |
| UL 498: | File E339607 |
| UL 514D: | File E339607 |
| UL 1310: | File E339607 |
| CAN/CSA C22.2 No. 223: | File E339607 |
| Warranty: | 1 Year |

| | |
|----------------------|-----------------|
| Patent Number | US 7,997,925 B2 |
|----------------------|-----------------|

Wiring Diagram

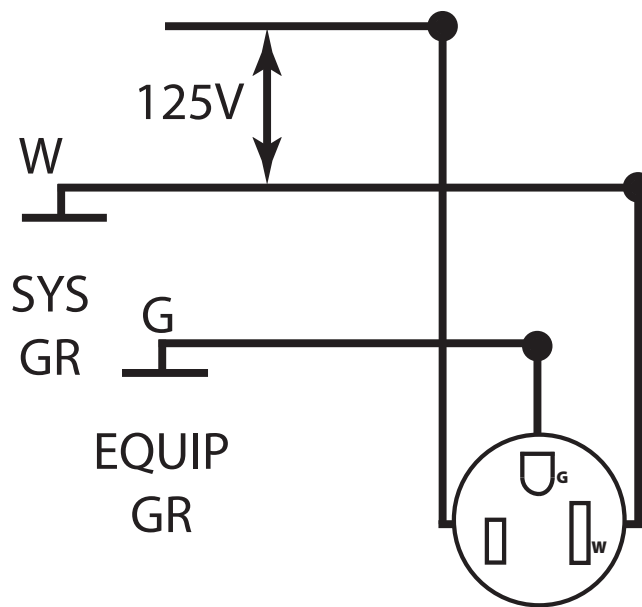

5-15R

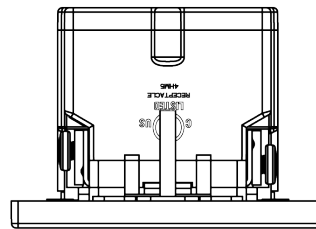
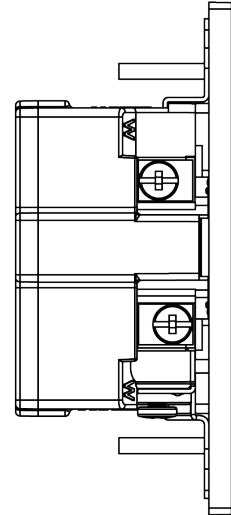
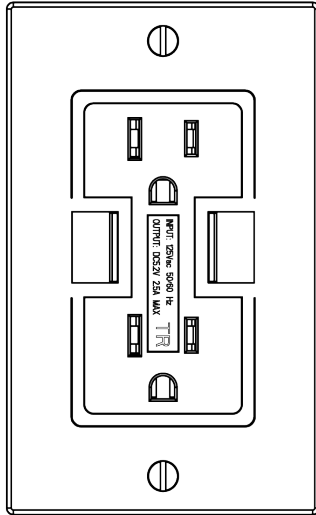
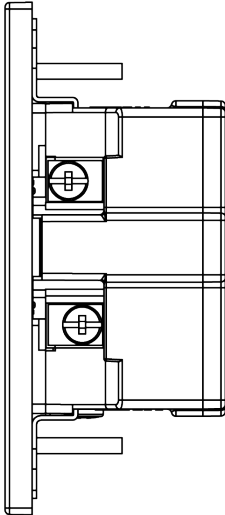
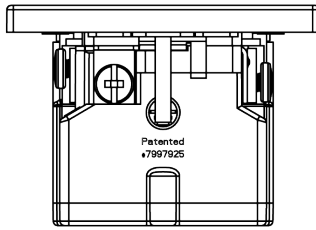
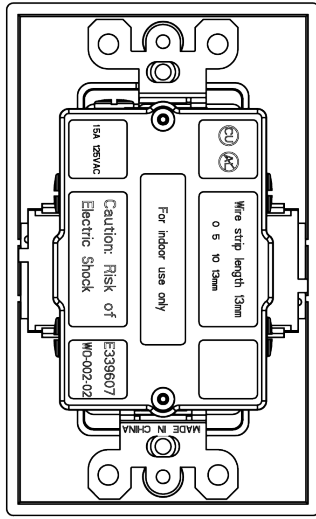

Newer Technology, Inc.
 2650 Bridge Lane, Woodstock, IL 60098
 Telephone: (815) 308-7001