

PRODUCT SPECIFICATIONS / INFO



Newer Technology Power2USB NWTPWR2U20ATRA

UPC Code: 811643012783

Country Of Origin: China

Description:

AC Description: 20 Amp Tamper Resistant, 125 Volt, NEMA 5-20R, 2P, 3W, Decora Body Duplex Receptacle, Straight Blade, Residential Grade, Self Grounding, Back & Side Wired, Steel Strap - Light Almond

DC Description: 5.2 Volt, 2500mA (12.5W) Duplex USB Charging Receptacle, With Integrated On/Off Safety Switch for USB Power

Color: Light Almond

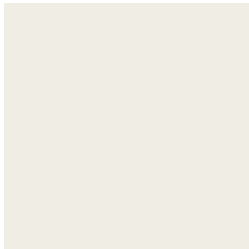

NEMA: 5-20R



Product Features

AC Horsepower Ratings

At rated voltage: 1/2HP

Electrical Specifications

Grounding:	Self
Amperage:	20 Amp
Voltage:	125 Volt
NEMA:	5-20R
Pole:	2
Wire:	3
Dielectric Voltage:	Withstands 2000V per UL 498
Overload Test, HP Rating:	125V AC, 58.8A
Current Limiting:	Full Rated Current
Temperature Rise:	Maximum contact temperature rise 25.9°C; Max terminal temperature rise 24.1 °C

Environmental Specifications

Flamability:	Rated V-2 per UL94
Operating Temperature:	-40C to 60C

Material Specifications

Face Material:	Polycarbonate
Body Material:	Polycarbonate
Line Contacts:	Brass Triple-Wipe .031 Thick
Terminal Screws:	Brass 10-32
Grounding Screw:	Brass 8-32
Strap Material:	Zinc-Plated Steel
Clamp Nuts:	Zinc-Plated Steel
Ground Clips:	Brass-Plated
Color:	Light Almond

Mechanical Specifications

Terminal ID:	Brass-Hot, Green-Ground, Silver-Neutral
Terminal Accomodation:	14-10 AWG
Product ID:	Ratings are marked on device
Termination:	Side

Standards and Certifications

NEMA:	WD-1 & WD-6
ANSI:	C-73
UL 498:	File E339607
UL 514D:	File E339607
UL 1310:	File E339607
CAN/CSA C22.2 No. 223:	File E339607
Warranty:	1 Year

Patent Number	US 7,997,925 B2
----------------------	-----------------

Wiring Diagram

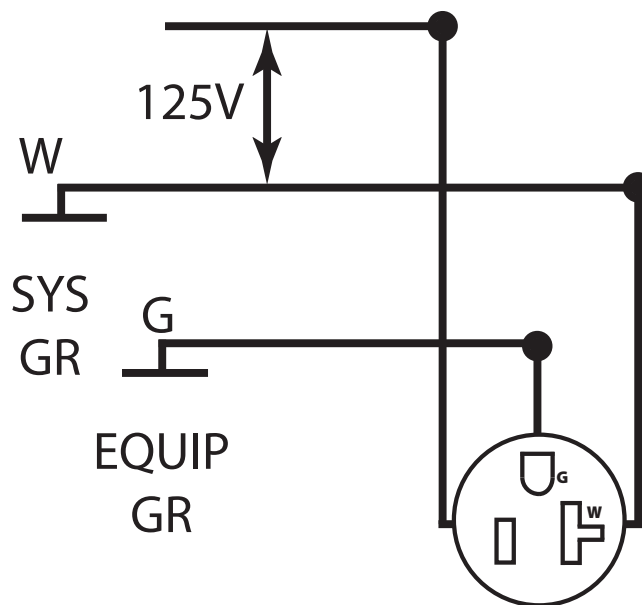

5-20R

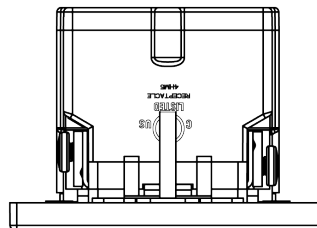
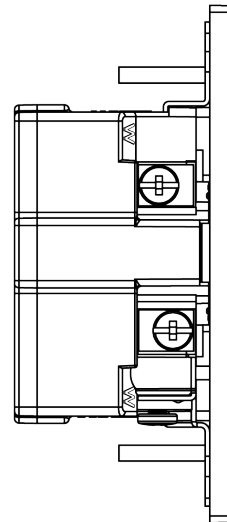
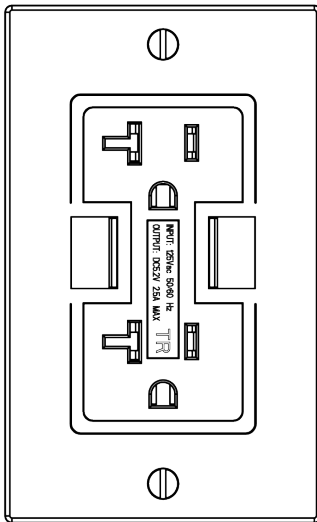
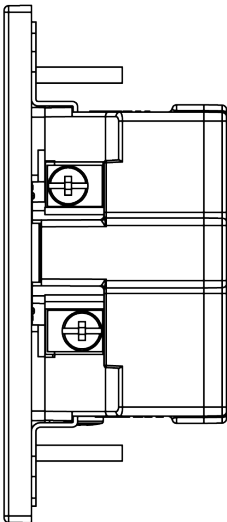
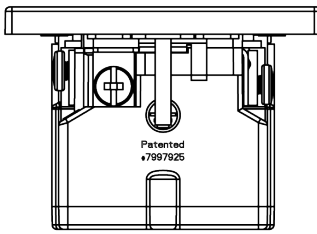
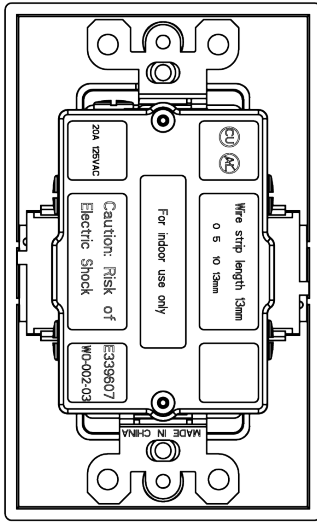

Newer Technology, Inc.
 2650 Bridge Lane, Woodstock, IL 60098
 Telephone: (815) 308-7001